

A

B

C

D

A

B

C

D

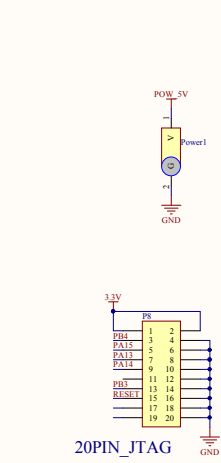
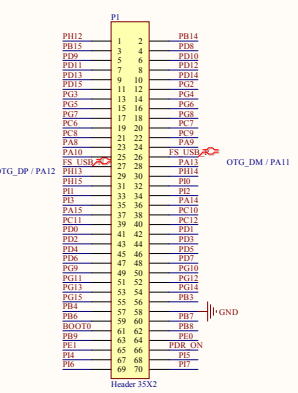
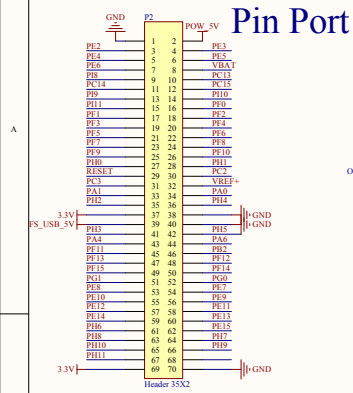

Joystick

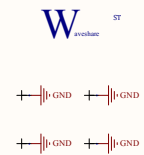

USER LED

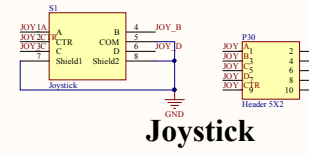

Joystick

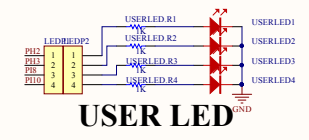

USER LED

FSMC LCD

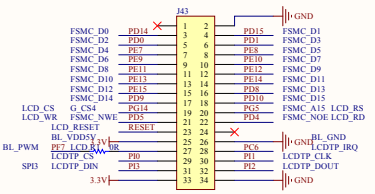

USART3

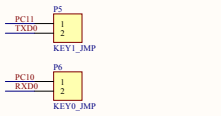

Pin Port

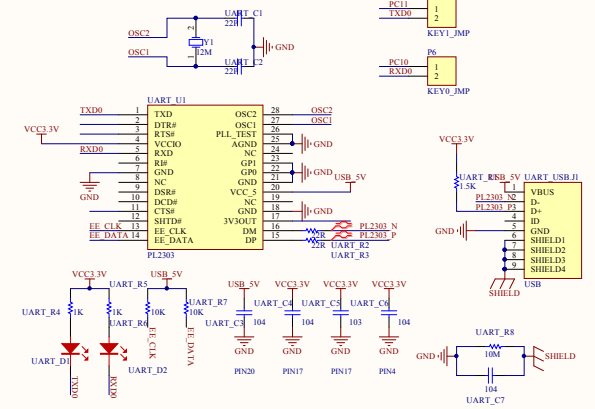
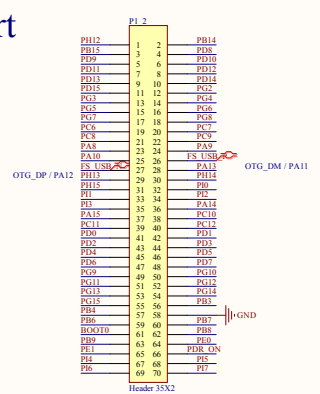
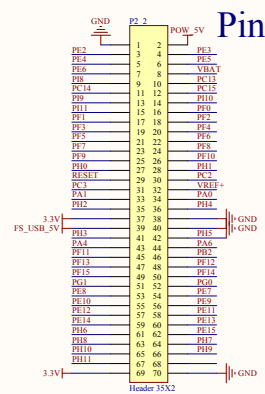

UART0